

(12) Japanese Unexamined Patent Application Publication

(11) Publication No. 7-302159

(43) Publication Date: November 14, 1995

(21) Application No. 6-114394

(22) Application Date: April 28, 1994

(71) Applicant: SEGA ENTERPRISES, LTD

1-2-12, Haneda, Ohta-ku, Tokyo

(72) Inventor: Terajima et al.

c/o SEGA ENTERPRISES, LTD

1-2-12, Haneda, Ohta-ku, Tokyo

(74) Agent: Patent Attorney, Yoshiyuki INABA

(54) Title of the Invention SWITCHING DEVICE

(57) [Abstract]

[Purpose] To provide a switching device that supplies a great deal of information without the need for selecting commands.

[Construction] A switching device 1 outputs electrical signals responsive to an operational amount and an operational time of a switch, and feeds the electrical signals to an information processing device 7. The switching device 1 includes a switch 3 which generates a signal relating to the operational amount when the switch 3 is operated, and a signal output means 5 which converts the signal relating to the operational amount into a signal relating to the operational time. A button 14 is vertically

movably supported on a cover 13 of the switch 3. A movable contact 15 is secured to the bottom end of the button 14, and is always upwardly urged by a coil spring, etc. The movable contact 15 is fabricated of an electrically conductive rubber G having a constant resistance. Semicircular conductors 18 and 18 with a spacing 19 interposed therebetween face the movable contact 15, and are arranged in a generally circular layout. The switch 3 outputs a change in resistance between the two semicircular conductors 18 as the signal relating to the operational amount and a signal output means 3 outputs the signal relating to the operational time.

[CLAIMS]

[Claim 1] A switching device comprising a switch which outputs a signal relating to an operational amount when the switch is operated, and a signal output means which outputs an electrical signal relating to an operational time based on the signal relating to the operational amount of the switch.

[Claim 2] A switching device according to claim 1, wherein the switch comprises a movable contact formed of an electrically conductive rubber and fixed to an operation button, conductive fixed contacts arranged in a circular configuration with a gap interposed therebetween in a

position facing the movable contact, a resistance measuring unit which measures a resistance from the conductive fixed contacts, and an A/D converter unit which converts an analog quantity from the resistance measuring unit into a digital signal.

[Claim 3] A switching device according to claim 1, wherein the switch includes a movable magnet fixed to an operation button, a fixed coil including a coiled conductive wire fixed in a position facing the movable magnet, an operational amplifier which amplifies a voltage generated in the fixed coil, and an A/D converter which converts an analog quantity from the operational amplifier into a digital signal.

[Claim 4] A switching device according to claim 1, wherein the switch includes a movable electrode fixed to an operation button, a fixed electrode fixed in a position facing the movable electrode, a means for imparting charge to the two electrodes, an operational amplifier which amplifies a voltage responsive to a capacitance between the two electrodes, and an A/D converter which converts an analog quantity from the operational amplifier into a digital signal.

[Claim 5] A switching device according to one of claims 1, 2, 3, and 4, wherein the signal output means comprises an operational time detector circuit which

converts an analog signal relating to the operational amount of the switch into a digital signal relating to the operational time.

[Claim 6] A switching device according to claim 5, wherein the operational time detector circuit comprises a comparator which detects that an analog signal relating to the operational amount from the switch becomes equal to or larger than a predetermined value, a maximum value detector circuit which detects that the analog signal reaches a maximum value, a flipflop which is set by an output signal from the comparator, and reset by the maximum value detector circuit, and a timer which is stopped by an output of the flipflop.

[Claim 7] A switching device according to claim 1, wherein the switch comprises a trapezoidally shaped, electrically conductive, movable rubber contact fixed to an operation button and a fixed contact assembly composed of a plurality of regularly spaced electrodes in a position facing the movable contact, and wherein a digital quantity relating to the operational amount is output in response to a contact area of the electrically conductive rubber contact in contact with the electrodes.

[Claim 8] A switching device according to claim 1, wherein the switch comprises a semi-spherically shaped, electrically conductive, movable rubber contact fixed to a

button and a fixed contact assembly composed of a central electrode placed in the center of the assembly in a position facing the movable contact, and a plurality of regularly spaced rings of electrodes centered on the central electrode, and wherein a digital quantity relating to the operational amount is output in response to a contact area of the electrically conductive rubber contact in contact with the electrodes.

[Claim 9] A switching device according to one of claims 1, 7 and 8, wherein the signal output means comprises an operational time detector circuit which converts a digital quantity relating to the operational amount into a digital signal relating to the operational time.

[Claim 10] A switching device according to claim 1, wherein the operational time detector circuit includes an information processing device which converts a digital quantity relating to the operational amount into a digital signal relating to the operational time.

[Detailed Description of the Invention]

[0001]

[Technical Field of the Invention] The present invention relates switching devices and, in particular, to a switching device for use in a game machine. More specifically, the present invention relates to a switching device which is applied to a push button switch, etc.,

arranged on a control panel of a game machine, for controlling the operation of a character presented on a screen of a display unit.

[0002]

[Description of the Related Arts] Japanese Unexamined Patent Application Publication No. 63-29113 discloses this sort of switching device. This conventional switching device relates to a mouse, which includes a button to be pressed down by a finger, a pressure sensor which outputs an analog signal having a different value in response to a force applied on the button, and an A/D converter for converting the analog signal to a digital signal. When a force acting on the button is weaker, digital data having a smaller value is output. When a force acting on the button is stronger, digital data having a larger value is output.

[0003] Besides information relating to an on and off state of the button, the switching device outputs different information as to the magnitude of force applied on the button to an information processing device. The information processing device thus can perform a variety of processes.

[0004]

[Problems to be Solved by the Invention] As already discussed, the above-referenced switching device outputs, to the information processing device, the information about the on and off state of the button and the information as to

pressure acting on the button. If a user attempts to output another piece of information, the user must input and select another command on the screen of a display of the information processing device and then must press the button. This inconveniences the user. The information allowed to be input is limited to the information relating to the on and off operation of the switch and the pressure applied on the button.

[0005] In a game machine as one of the information processing devices, the user operates the button arranged on the control panel, thereby controlling the operation of the character. If the user controls the operation of the character in response to the magnitude of the pressure applied on the button only, the mode of operation of the character is limited. There is a need for causing the character to move in response to the speed at which the button is pressed.

[0006] To resolve this problem, it is the object of the present invention to provide a switching device which presents more pieces of information without the need for selecting commands.

[0007]

[Means for Solving the Problems] To achieve the above object, a switching device of the present invention includes a switch which outputs a signal relating to an operational

amount when the switch is operated, and a signal output means which outputs an electrical signal relating to an operational time based on the signal relating to the operational amount of the switch.

[0008] The switch of the switching device of the present invention includes a movable contact formed of an electrically conductive rubber and fixed to an operation button, conductive fixed contacts arranged in a circular configuration with a gap interposed therebetween in a position facing the movable contact, a resistance measuring unit which measures a resistance from the conductive fixed contacts, and an A/D converter unit which converts an analog quantity from the resistance measuring unit into a digital signal.

[0009] The switch of the switching device of the present invention includes a movable magnet fixed to an operation button, a fixed coil including a coiled conductive wire fixed in a position facing the movable magnet, an operational amplifier which amplifies a voltage generated in the fixed coil, and an A/D converter which converts an analog quantity from the operational amplifier into a digital signal.

[0010] The switch of the switching device of the present invention includes a movable electrode fixed to an operation button, a fixed electrode fixed in a position

facing the movable electrode, a means for imparting charge to the two electrodes, an operational amplifier which amplifies a voltage responsive to a capacitance between the two electrodes, and an A/D converter which converts an analog quantity from the operational amplifier into a digital signal.

[0011] A signal output means of the switching device of the present invention includes an operational time detector circuit which converts an analog signal relating to the operational amount of the switch into a digital signal relating to the operational time.

[0012] The operational time detector circuit of the switching device of the present invention includes a comparator which detects that an analog signal relating to the operational amount from the switch becomes equal to or larger than a predetermined value, a maximum value detector circuit which detects that the analog signal reaches a maximum value, a flipflop which is set by an output signal from the comparator, and reset by the maximum value detector circuit, and a timer which is stopped by an output of the flipflop.

[0013] The switch of the switching device of the present invention includes a trapezoidally shaped, electrically conductive, movable rubber contact fixed to an operation button and a fixed contact assembly composed of a

plurality of regularly spaced electrodes in a position facing the movable contact, and wherein a digital quantity relating to the operational amount is output in response to a contact area of the electrically conductive rubber contact in contact with the electrodes.

[0014] The switch of the switching device of the present invention includes a semi-spherically shaped, electrically conductive, movable rubber contact fixed to a button and a fixed contact assembly composed of a central electrode placed in the center of the assembly in a position facing the movable contact, and a plurality of regularly spaced rings of electrodes centered on the central electrode, and wherein a digital quantity relating to the operational amount is output in response to a contact area of the electrically conductive rubber contact in contact with the electrodes.

[0015] The signal output means of the switching device of the present invention includes an operational time detector circuit which converts a digital quantity relating to the operational amount into a digital signal relating to the operational time.

[0016] The operational time detector circuit of the present invention includes an information processing device which converts a digital quantity relating to the operational amount into a digital signal relating to the

operational time.

[0017]

[Operation] When an operation switch is operated, the switch generates a signal responsive to an operation of the switch. The operational amount of the switch is then fed to a subsequent processing device. The signal output means outputs electrical signals relating to the operational time based on the operational amount of the switch. A game machine controls the distance of travel and travel speed of a character based on the electrical signals relating to the operational amount and the operational time from the switch.

[0018] When the electrically conductive movable rubber contact comes into contact with the fixed conductive contacts which are insulated from each other and are arranged in a generally circular layout, the electrically conductive rubber is deformed, and the resistance between the two conductors changes. The resistance change is converted into a voltage value, which is treated as an electrical signal representing the operational amount of the switch. The signal output means produces an electrical signal representing operational speed information, based on the electrical signal representing the operational amount of the switch.

[0019] When the movable magnet approaches the fixed coil in the switch, a voltage is generated in the fixed coil

through the right-handed screw rule. This voltage is an electrical signal representing the operational amount of the switch, and the signal output means converts the electrical signal into an electrical signal representing operational speed information.

[0020] The switch includes a movable electrode, a fixed electrode, and a charge supply means. Let S represent the area of each of the movable electrode and the fixed electrode, d represent the distance between the movable electrode and the fixed electrode, and ϵ represent a dielectric constant between the two electrodes, and a capacitance C is $C = \epsilon S / d$. When the operation of a button changes the distance d between the two electrodes, the capacitance C also changes. In response, the signal output means changes the voltage thereof, thereby resulting in the electrical signals representing the operational amount and operational speed.

[0021] The signal output means includes the operation time detector circuit, which converts the analog signal relating to the operational amount of the switch into a digital signal.

[0022] The operational time detector circuit sets the flipflop when the comparator detects that the analog signal relating to the operational amount of the switch becomes equal to or greater than the predetermined value,

and resets the flipflop when the comparator detects that the analog signal reaches the maximum value. In this way, the rising edge of a first half of the analog signal is detected, and the time of the analog signal is counted by the timer, and the operational time is thus detected.

[0023] When the trapezoidally shaped, electrically conductive, movable rubber contact is put into contact with the fixed contact assembly composed of the plurality of regularly spaced electrodes in a position facing the movable contact in the switch, the electrically conductive rubber is deformed and comes into contact with each electrode. In this way, the contact area of the electrically conductive rubber with each electrode changes. A change in the contact area becomes a signal representing whether the electrically conductive rubber is in contact with or out of contact with the electrode, and the signal is a digital signal representing the contact state of the plurality of electrodes.

[0024] When the semi-spherically shaped, electrically conductive, movable rubber contact is in contact with the fixed contact assembly composed of the central electrode placed in the center of the assembly in a position facing the movable contact, and the plurality of regularly spaced rings of electrodes centered on the central electrode, in the switch, the electrically conductive rubber

is deformed, and comes into contact with the electrodes, from the central electrode to radially external electrodes. A change in the contact area becomes a signal representing whether the electrically conductive rubber is in contact with or out of contact with the electrode. Since the plurality of electrodes are employed, the signal is a digital quantity response to the contact area of the electrically conductive rubber.

[0025] The signal output means includes the operational time detector circuit which converts a digital quantity relating to the operational amount into a digital signal relating to the operational time.

[0026] The operational time detector circuit may include an information processing device, such as a computer, which converts a digital quantity relating to the operational amount into a digital signal relating to the operational time using a software program.

[0027]

[Embodiments] The embodiments of the present invention are now discussed, referring to the drawings.

<First Embodiment> FIG. 1 is a block diagram of an information processing device to which one embodiment of the switching device of the present invention is connected.

[0028] The switching device 1 shown in FIG. 1 is designed to output electrical signals relating to the

operational amount and the operational time of a switch. The switching device 1 is electrically connected to an information processing device 3, and supplies with the information processing device 3 with the electrical signals responsive to the operational amount and the operational amount of the switch.

[0029] The switching device 1 includes a switch 3 which outputs an electrical signal responsive to the operational amount when it is operated, and a signal output means 5 which produces a signal relating to the operational time of the switch based on the electrical signal responsive to the operational amount of the switch 3.

[0030] The switch 3 includes mechanical components such as a cover 13, a button 14, a movable contact 15, a fixed contact 16, and a resistor 17, and electrical components such as a resistance measuring unit 21, and an A/D converter 22.

[0031] The mechanical components of the switch 3 are arranged as follows. The cover 13 is an external frame forming a device body of the switch 3. The button 14 is vertically movably supported on the cover 13 as shown. The top side portion of the button 14 serves as a control end and the movable contact 15 is fixed to the bottom end of the button 14. The button 14 is always urged by an unshown coil spring, etc. The movable contact 15 is formed of a semi-

spherical, electrically conductive rubber G. The electrically conductive rubber G has a constant resistance. Semicircular conductors 18 and 18 arranged with a spacing 19 interposed therebetween in a generally disklike configuration are placed in a position facing the movable contact 15. The resistor 17 is connected in parallel with the semicircular conductors 18 and 18. The resistor 17 is also configured with one thereof grounded, and with the other end connected to one input terminal of the resistance measuring unit 21 of a signal output means 12.

[0032] The electrical system of the switch 3 is constructed as follows. The resistance measuring unit 21 is configured with one input thereof connected to the other end of the resistor 17, and with the other input terminal grounded. The resistance measuring unit 21 thus detects a change and a rate of change in the resistance between the semicircular conductors 18 and 18. The output terminal of the resistance measuring unit 21 is connected to the A/D converter 22. The A/D converter 22 converts the resistance and the rate of change in resistance per unit time from the resistance measuring unit 21 into a digital signal.

[0033] The output terminals of the resistance measuring unit 21 are connected to the input terminals of the signal output means 5. The signal output means 5 receives an electrical analog signal responsive to the

operational amount of the button 14 from the resistance measuring unit 21. The signal output means 5 then produces a digital signal relating to the operational time based on the electrical analog signal responsive to the operational amount, and outputs the digital signal at the output terminals thereof. The output terminals of the signal output means 5 are connected to an interface 72 of the information processing device 7. The digital signal relating to the operational time is thus fed to a CPU 71 through the interface 72.

[0034] The A/D converter 22 of the switch 3 outputs a digital signal in a parallel format. The parallel output terminals of the A/D converter 22 are connected to parallel input and output terminals of the interface 72 of the information processing device 7.

[0035] In this embodiment, the information processing device 3 includes the CPU 71 and interface 72 only as shown, but in practice, the information processing device 3 further includes a ROM, a RAM, an I/O unit, a display unit, an external storage unit, and other units required for other processes.

[0036] FIG. 2 is a block diagram showing a specific circuit arrangement of the signal output means 5. Referring to FIG. 2, the signal output means 5 includes an operational time detector circuit 51. The operational time detector

circuit 51 includes a comparator 52, a maximum time detector circuit 53, a flipflop 54, and a timer 55. The output terminals of the resistance measuring unit 21 are connected to the input terminals of the comparator 52 and the maximum time detector circuit 53. The resistance-voltage converter circuit 1 supplies an analog operational amount signal to the comparator 52 and the maximum time detector circuit 53. The output terminal S of the comparator 52 is connected to the set terminal of the flipflop 54. The output terminal of the maximum time detector circuit 53 is connected to the reset terminal R of the flipflop 54. The flipflop 54 receives, at the clock terminal CP thereof, a drive clock. The non-inverted output terminal Q of the flipflop 54 is connected to the disable control input terminal of the timer 55. Only when the output terminal Q is at "1", the timer 55 is operative. The inverted output terminal RQ of the flipflop 54 is connected to the reset terminal of the maximum time detector circuit 53.

[0037] The timer 55 is constructed as follows, for example. The timer 55 includes a reference clock generator circuit 551, a gate 552, and a counter 553. The output signal at the non-inverted output terminal Q of the flipflop 54 is fed to one input terminal of the gate 552, and the output terminal of the reference clock generator circuit 551 is connected to the other input terminal of the gate 552.

The output terminal of the gate 552 is connected to the input terminal of the counter 553.

[0038] The embodiment thus constructed is discussed, referring to FIG. 1 through FIG. 4. FIG. 3 shows resistance characteristics of the switching device with respect to the operation of the switching device. The abscissa represents time, while the ordinate represents resistance. FIG. 4 illustrates the relationship between a change in voltage and a signal relating to the operational time, wherein the abscissa represents time while the ordinate represents the change in voltage.

[0039] When the button 14 is pressed downward against the urging of an unshown coil spring in the switching device 1 thus constructed, the electrically conductive rubber G of the movable contact 15 comes into contact with the semicircular conductors 18 and 18 of the fixed contact 16. The semicircular conductors 18 and 18 are connected to each other through the electrically conductive rubber G of the movable contact 15, and the resistance between the semicircular conductors 18 and 18 becomes smaller than the resistance of the resistor 17. When further pressed into contact with the semicircular conductors 18 and 18, the electrically conductive rubber G of the movable contact 15 is deformed. The contact area of the electrically conductive rubber G of the movable contact

15 is increased, and the contact resistance of the electrically conductive rubber G having a constant resistance with the semicircular conductors 18 and 18 gradually decreases. Table 1 lists one example of the relationship between the contact area of the electrically conductive rubber G with the semicircular conductors 18 and 18 and the resistance value measured by the resistance measuring unit 21.

[0040]

[Table 1]

[0041] As listed in Table 1, the resistance sum R_0 is the sum of the resistance of the resistor 17 and the contact resistance of the electrically conductive rubber G, and $\text{resistance/area} = R/\text{cm}^2$.

[0042] The resistance sum R_0 changing in this way is measured by the resistance measuring unit 21. FIG. 3 shows the change in the resistance sum R_0 . A portion (a) of FIG. 3 shows an operational example, in which the operational amount is small while the operational speed is slow. A change ΔR_a in the resistance sum R_0 is small, while the operational time Δt_a is long. A portion (b) of FIG. 3 shows an operational example, in which the operational amount is large, while the operational speed is fast. The change ΔR_b in the resistance sum R_0 is large, while the operational

time Δt_b is short. A portion (c) of FIG. 3 shows an operational example, in which the operational amount is large, while the operational speed is fast. The change ΔR_c in the resistance sum R_o is large, while the operational time Δt_c is short.

[0043] When the resistance measuring unit 21 measures the change in the resistance sum R_o , the resistance measuring unit 21 generates a voltage responsive to the change in the resistance of the resistance sum R_o . This analog signal contains, as information as to changes in the resistance sum R_o , a change ΔR , time Δt for change, and the integral of change ΔR in the form of voltage signal. The output voltage from the resistance measuring unit 21 is converted into a digital signal by the A/D converter 22.

[0044] The analog signal output from the resistance measuring unit 21 is fed to the comparator 52 and the maximum time detector circuit 53. When the analog signal rises above a reference voltage E_o , the comparator 52 outputs "1". When the output of the comparator 52 reaches "1", the flipflop 54 is set, and the flipflop 54 outputs "1". The timer 55 is thus activated. Specifically, the gate 552 is opened, and the reference clock is fed from the reference clock generator circuit 551 to the counter 553. The counter 553 counts the reference clock. The maximum time detector circuit 53 monitors the input analog signal, and outputs "1".

when it detects a voltage smaller than the immediately preceding input voltage. In this way, the flipflop 54 is reset. The flipflop 54 outputs "0" at the non-inverted output terminal Q, thereby stopping the timer 55. The gate 552 is closed, and no reference clock is fed to the counter 553. In this way, the counter 553 measures time of the analog signal at the rising edge side. The flipflop 54 outputs "1" at the inverted-output terminal RQ, which is used to reset the maximum time detector circuit 53, and the switching device 1 is now ready for the detection of the next maximum value.

[0045] The digital signal obtained from the A/D converter 22 and the digital signal obtained from the timer 55 of the signal output means 5 are input to the CPU 71 through the interface 72. When the CPU 71 is used as a game machine, a character is moved by a distance of travel corresponding to the change ΔR in the resistance, based on the change ΔR in the resistance of the resistance sum R_0 and the time segment Δt for the change. In this case, the character is moved within a short or long period of time depending on the time segment Δt . Using the integral of the change in the resistance sum R_0 , the CPU 71 expresses the magnitude of an impact from which the character suffers when it collides with another character.

[0046] Since the information relating to the

operation of the button 14 includes the change in the operation, the time segment for the change, and the operational amount in accordance with the first embodiment, the information processing device can perform complex processes.

[0047] <Second Embodiment> FIG. 5 is a block diagram of a second embodiment of the switching device which is connected to the information processing device. In the second embodiment, components identical to those described in connection with the first embodiment are designated with the same reference numerals.

[0048] A switching device 1a shown in FIG. 5 is designed to output electrical signals responsive to an operational amount and operational time. The switching device 1a is electrically connected to the information processing device 7 to feed the electrical signals responsive to an operational amount and operational time to the information processing device 7. The switching device 1a includes a switch 3a which outputs an electrical signal responsive to an operational amount of the switch 3a when the switch 3a is operated, and a signal output means 5a which produces a signal relating to operational time of the switch 3a based on the electrical signal responsive to the operational amount of the switch 3a.

[0049] The switch 3a includes a cover 13, a button

14, a movable magnet 15a, and a fixed coil 16a. The cover 13 is an external frame forming a device body of the switch 11a. The button 14 is vertically movably supported on the cover 13 as shown. The second embodiment is different from the first embodiment in that the movable magnet 15a is fixed to the bottom end of the button 14, but the first and second embodiments are identical in that the button 14 is always urged upwardly by an unshown coil spring. The movable magnet 15a is aligned so that it has an N pole at the bottom end thereof and an S pole at the top end thereof. There will be no problem if the polarization is inverted. The fixed coil 16a is arranged in a position facing the movable magnet 15a. The fixed coil 16a is produced by winding an insulated wire having an insulator coating in a spiral configuration or in a coil configuration. Both ends of the fixed coil 16a are connected to both input terminals of an operational amplifier 21a. The output of the operational amplifier 21a is connected to the A/D converter 22. The operational amplifier 21a has the inverting input terminal and the non-inverting input terminal, to which both ends of the fixed coil 16a are connected. The operational amplifier 21a amplifies a change in the voltage and the rate of the change taking place in the fixed coil 16a. The output of the operational amplifier 21a is connected to the A/D converter 22. The A/D converter 22 converts a change in the

voltage value from the operational amplifier 21a into a digital signal. The A/D converter 22 outputs the digital signal in a parallel format. The parallel output terminals of the A/D converter 22 are connected to input and output terminals of an interface 72.

[0050] The construction of the signal output means 5a is fully identical to the counterpart in the first embodiment, and the discussion thereof is skipped. The information processing device 7 is also fully identical to that in the first embodiment, and the discussion thereof is also skipped.

[0051] When the button 14 is pressed downward in the switching device 1a, the movable magnet 15a approaches the fixed coil 16a. In response to the speed of the button 14, a voltage is generated in the fixed coil 16a through the right-handed screw rule. The voltage increases or decreases in proportion to the speed of the downward motion of the button 14, and a change in the voltage is amplified by the operational amplifier 21a, and is then converted into a digital signal by the A/D converter 22. The digital signal is then fed to a CPU 71 through the interface 72 in the information processing device 7.

[0052] An operational time detector circuit 51 in the signal output means 5 obtains a digital signal relating to the speed of the button 14 when pressed, from the change

in the voltage. The digital signal relating to the operational time is fed to the CPU 71 through the interface 72.

[0053] The CPU 71 in the information processing device 7 performs a variety of processes using the digital signals relating to the above-referenced operational amount and operational time. If the CPU 71 is applied in a game machine, the same process as that described in connection with the first embodiment is performed.

[0054] Since the information relating to the operation of the button 14 includes the change in the operation, the time segment for the change, and the operational amount in accordance with the second embodiment, the information processing device can perform complex processes.

[0055] <Third Embodiment> FIG. 6 is a block diagram of a third embodiment of the switching device which is connected to the information processing device. In the third embodiment, components identical to those described in connection with the first embodiment are designated with the same reference numerals.

[0056] A switching device 1b shown in FIG. 6 is designed to output electrical signals responsive to an operational amount and operational time. The switching device 1b is electrically connected to the information

processing device 7 to feed the electrical signals responsive to an operational amount and operational time to the information processing device 7.

[0057] As in the first embodiment, the switching device 1b includes a switch 3a which outputs an electrical signal responsive to an operational amount of the switch 3a when the switch 3a is operated, and a signal output means 5a which produces a signal relating to operational time of the switch 3a based on the electrical signal responsive to the operational amount of the switch 3a.

[0058] The switch 11b includes a cover 13, a button 14, a movable electrode 15b, and a fixed electrode 16b. The third embodiment is identical to the first embodiment in that the cover 13 is an external frame forming a device body of the switch 11b, and that the button 14 is vertically movably supported on the cover 13 as shown. The third embodiment is different from the first embodiment in that the movable electrode 15b is fixed to the bottom end of the button 14, but is identical to the first embodiment in that the button 14 is always upwardly urged. The fixed electrode 16b is arranged in a position facing the movable electrode 15b. The movable electrode 15b is out of reach of the fixed electrode 16b even when the movable electrode 15b is pressed by the maximum stroke. The movable electrode 15b and the fixed electrode 16b are charged by an unshown direct current

power supply so that the movable electrode 15b is positively charged while the fixed electrode 16b is negatively charged. The movable electrode 15b is connected to the non-inverting input terminal of an operational amplifier 21b of the signal output means 12b while the fixed electrode 16b is connected to the inverting input terminal of the signal output means 12b. The output terminal of the operational amplifier 21b is connected to the A/D converter 22. The operational amplifier 21b is configured with the non-inverting input terminal thereof connected to the movable electrode 15b and with the inverting input terminal thereof connected to the fixed electrode 16b, and amplifies a capacitance change responsive to a change in the spacing between the movable electrode 15b and the fixed electrode 16b and a rate of capacitance change in the form of voltage. The output terminal of the operational amplifier 21b is connected to the A/D converter 22. The A/D converter 22 converts the voltage signal of the capacitance and the rate of change of capacitance per unit time from the operational amplifier 21b into a digital signal. The A/D converter 22 outputs the digital signal as a parallel signal. The parallel output terminals of the A/D converter 22 are connected to parallel input and output terminals of the interface 72.

[0059] A signal output means 5b is identical in construction to the counterpart in the first embodiment.

The input terminal of the signal output means 5b is connected to the output terminal of the operational amplifier 21b. The output terminals of the signal output means 5b are connected to parallel input and output terminals of the interface 72 of the information processing device 7. Since the information processing device 7 is fully identical to that in the first embodiment, the discussion thereof is skipped.

[0060] When the button 14 is pressed downward in the switching device 1b, the spacing between the movable electrode 15b and the fixed electrode 16b is narrowed, thereby changing the capacitance therebetween. Since the capacitance increases or decreases in inversely proportional to the spacing between the movable electrode 15b and the fixed electrode 16b. The change in the capacitance is converted into a voltage change by the operational amplifier 21b. The voltage is then converted into a digital signal by the A/D converter 22. The digital signal is then transferred to the CPU 71 through the interface 72.

[0061] The signal output means 5b detects a change in the capacitance in response to the operation of the button 14, calculates a change in the operation such as a speed, and outputs the operational change in a digital signal.

[0062] The two digital signals are fed to the CPU 71.

through the interface 72 in the information processing device 7. The CPU 71 performs a variety of processes. For example, if the CPU 71 is employed in a game machine, the CPU 71 performs the same process as that performed in the first embodiment.

[0063] Since the information relating to the operation of the button 14 includes the change in the operation, the time segment for the change, and the operational amount in accordance with the third embodiment, the information processing device can perform complex processes.

[0064] <Fourth Embodiment> FIG. 7 is a block diagram of a fourth embodiment of the switching device which is connected to the information processing device. In the fourth embodiment, components identical to those described in connection with the first embodiment are designated with the same reference numerals.

[0065] A switching device 1c shown in FIG. 7 is designed to output electrical signals responsive to an operational amount and operational time. The switching device 1c is electrically connected to the information processing device 7 to feed the electrical signals responsive to an operational amount and operational time to the information processing device 7.

[0066] The switching device 1c includes a switch 3a.

which outputs an electrical signal responsive to an operational amount of the switch 3a when the switch 3a is operated, and a signal output means 5a which produces a signal relating to operational time of the switch 3a based on the electrical signal responsive to the operational amount of the switch 3a.

[0067] The switch 3c is constructed as follows. Specifically, the switching device 1c includes a cover 13, a button 14, a movable contact 15c, and a fixed contact 16c. The fourth embodiment is identical to the first embodiment in that the cover 13 is an external frame forming a device body of the switch 1c, and that the button 14 is vertically movably supported on the cover 13 as shown. The fourth embodiment is different from the first embodiment in that the button 14 has a movable contact 15c fixed to the bottom end thereof and formed of a trapezoidally shaped, electrically conductive rubber G. The electrically conductive rubber G has a bottom face inclined from a small thickness portion at the left hand side to a large thickness portion at the right hand side as shown. As in the first embodiment, the button 14 is always upwardly urged by an unshown coil spring, etc. A fixed contact assembly 16c is arranged in a position facing the movable contact 15c. The fixed contact assembly 16c includes a plurality of electrodes 16c1, 16c2, 16c3, 16c4, and 16c5 with constant

spacings 19c1 between 16c1 and 16c2, 19c2 between 16c2 and 16c3, 19c3 between 16c3 and 16c4, and 19c4 between 16c4 and 16c5. The electrode 16c1 is grounded, while the remaining four electrodes 16c2, 16c3, 16c4, and 16c5 are connected to an interface 72 in the information processing device 7. In this way, a four-bit digital signal is output from the these electrodes. The interface 72 receives a clock CLOCK.

[0068] FIG. 8 is a circuit diagram showing the construction of an operational time detector circuit 51c of the signal output means 5c. In case of the four bit digital signal, the operational time detector circuit 51c includes three exclusive OR (EXOR) gates 56, 57, and 58, three flipflops 59, 60, and 61, three AND gates 62, 63, and 64, an OR gate 68, and a timer 55.

[0069] The electrode 16c2 is connected to one input terminal of the EXOR gate 56, and the electrode 16c3 is connected to the other input terminal of the EXOR gate 56. The electrode 16c3 is connected to the reset terminal of the flipflop 59. The electrode 16c3 is connected to one input terminal of the EXOR gate 57, and the electrode 16c4 is connected to the other input terminal of the EXOR 57. The electrode 16c4 is connected to the reset terminal of the flipflop 60. The electrode 16c4 is connected to one input of the EXOR gate 58 and the electrode 16c5 is connected to the other input terminal of the EXOR gate 58. The electrode

16c5 is connected to the reset terminal of the flipflop 61. Each of the flipflops 61, 62, and 63 receives the clock at the clock input terminal thereof, although these terminals and the clock are not shown. Upon completing counting, the timer 55 is designed to clear the flipflops 61, 62, and 63 so that the flipflops 61, 62, and 63 outputs "1" at the output terminals Q thereof. The output terminals Q of the flipflops 59, 60, and 61 are respectively connected to the other input terminals of the AND gates 62, 63, and 64. The output terminals of the EXOR gates 56, 57, and 58 are respectively connected the remaining input terminals of the AND gates 62, 63, and 64. The output terminals of the AND gates 62, 63, and 64 are respectively connected to the input terminals of the OR gate 65. The output terminal of the OR gate 65 is connected to the disable control input terminal of the timer 55. The timer 55 remains unchanged from that used in the first embodiment, and the discussion thereof is skipped here. The information processing device 7 is also identical to that used in the first embodiment, and the discussion thereof is also skipped here.

[0070] The operation of the fourth embodiment is now discussed, referring to FIG. 6 and FIG. 7. FIG. 7 is a timing diagram showing the operation of the fourth embodiment. The abscissa represents time, while the ordinate represents signals at various points of the circuit.

[0071] When the button 14 is pressed down against the urging of the unshown coil spring in the switching device 1 thus constructed, the electrically conductive rubber G of the movable contact 15c is put into contact with the electrode 16c1 of the fixed contact assembly 16c. When the button 14 is further pressed down, the electrically conductive rubber G is deformed into contact with the electrodes 16c1 and 16c2 of the fixed contact assembly 16c. When the button 14 is even further pressed down, the electrically conductive rubber G of the movable contact 15c is deformed into contact with the electrodes 16c1, 16c2, and 16c3 of the fixed contact assembly 16c. As the contact area of the electrically conductive rubber G of the movable contact 15c is widened, the electrodes 16c1, 16c2, 16c3, 16c4, and 16c5 are gradually grounded. The interconnection relationship between the electrically conductive rubber G and the electrodes 16c1, 16c2, 16c3, 16c4, and 16c5 is varied depending on the pressing force and speed acting on the button 14. The interconnection relationship of the electrodes 16c1, 16c2, 16c3, 16c4, and 16c5 of the fixed contact assembly 16c is fed to the interface 72 of the information processing device 7, and is then transferred to the CPU 71.

[0072] The flipflops 59, 60, and 61 are set to "1" at the output terminals Q thereof at the default conditions.

thereof. For example, when the electrodes 16c1 and 16c2 are put into contact with each other, the electrode 16c2 of the switch 3 becomes "0" in level (See FIG. 9(a)). This signal is output as the output of the switching device 1. In the signal output means 5, the on condition of the EXOR 56 is not established, the EXOR 56 is not activated, and the timer 55 remains inoperative. The timer 55 outputs no digital signal relating to the operational time.

[0073] When the electrodes 16c1, 16c2, and 16c3 are in contact with each other for a predetermined period of time, the electrodes 16c2 and 16c3 becomes "0" in level (see FIG. 9(b)). This signal is fed to the information processing device 7 as the output signal of the switch 3 of the switching device 1.

[0074] In the signal output means 5, the on condition of the EXOR 56 is established for a duration of time from t_1 to t_2 , and for a duration of time from time t_3 to time t_4 , and the EXOR 56 outputs "1" for the duration of time from time t_1 to time t_2 , and for the duration of time from time t_3 to time t_4 . Since the flipflop 59 becomes "0" at time t_2 , the AND gate 62 does not output "1" for the duration of time from time t_3 to time t_4 , but outputs "1" for the duration of time from time t_1 to time t_2 only. The level "1" is fed to the disable control input terminal of the timer 55 through the OR gate 65. In this way, the

duration of time from time t_1 to time t_2 is counted.

[0075] Furthermore, when the electrodes 16c1, 16c2, 16c3, and 16c4 are connected to each other for a predetermined period of time, the electrodes 16c2, 16c3, and 16c4 become "0" in level (see FIG. 9(c)). This signal is fed to the information processing device 7 as the output signal from the switch 3 in the switching device 1.

[0076] In the signal output means 5, the on condition of the EXOR gate 56 is established for a duration of time from time t_{11} to time t_{12} and for a duration of time from time t_{15} to time t_{16} and the on condition of the EXOR gate 57 is established for a duration of time from time t_{12} to time t_{13} and for a duration of time from time t_{14} to time t_{15} . As shown in FIG. 9(c), the EXOR gate 56 outputs "1" for the duration of time from t_{11} to time t_{12} and for the duration of time from time t_{15} to time t_{16} , and as shown in FIG. 9(c), the EXOR gate 57 outputs "1" for the duration of time from time t_{12} to time t_{13} and for the duration of time from time t_{14} to time t_{15} . Since the flipflop 60 is driven to "0" at the output terminal Q thereof at time t_{14} , the AND gate 63 does not output "1" at the output terminal thereof from the duration of time from time t_{14} to time t_{15} , but outputs "1" for the duration of time from time t_{13} to time t_{14} . Since the flipflop 59 is driven to "0" at the output terminal Q thereof at time t_{15} , the AND gate 62 does not

output "1" at the output terminal thereof for the duration of time from time t15 to time t16, but outputs "1" for the duration of time from time t11 to time t12. When these "1's" are fed to the OR gate 65, the OR gate outputs "1" at the output terminal thereof for the duration of time from time t11 to t13. This signal is fed to the disable control input terminal of the timer 55. The timer 55 counts time for the duration of time from time t11 to time t12.

[0077] When the electrodes 16c1, 16c2, 16c3, 16c4, and 16c5 are all connected to each other for a predetermined duration of time, the electrodes 16c2, 16c3, 16c4, and 16c5 becomes "0" in level (see FIG. 9(d)). This signal is fed to the information processing device 7 as the output signal of the switch 3. In the signal output means 5, the on condition of the EXOR gate 56 is established for a duration of time from time t21 to time t22 and for a duration of time from time t27 to time t28, and the on condition of the EXOR gate 57 is established for a duration of time from time t22 to time t23, and for a duration of time from time t26 to time t27, and the on condition of the EXOR gate 58 is established for a duration of time from time t23 to time t24, and for a duration of time from time t25 to time t26.

Referring to FIG. 9(d), the EXOR gate 56 outputs "1" at the output terminal thereof for the duration of time from time t21 to time t22 and for the duration of time from time t27

to time t28. Referring to FIG. 9(c), the EXOR gate 57 outputs "1" at the output terminal thereof for the duration of time from time t22 to time t23, and for the duration of time from time t26 to time t27. Referring to FIG. 9(d), the EXOR gate 58 outputs "1" at the output terminal thereof for the duration of time from time t23 to time t24, and for the duration of time from time t25 to time t26. Since the flipflop 61 is driven to "0" at the output terminal Q thereof at time t25, the AND gate 64 does not output "1" at the output thereof for the duration of time from time t25 to time t26, but outputs "1" for the duration of time from time t23 to time t24. Since the flipflop 60 is driven to "0" at the output thereof at time t25, the AND gate 63 does output "1" at the output terminal thereof for the duration of time from time t26 to time t27, but outputs "1" for the duration of time from time t23 to t24. Since the flipflop 59 is driven to "0" at the output terminal Q thereof at time t27, the AND gate 62 does not output "1" at the output terminal thereof for the duration of time from time t27 to time t28, but outputs "1" for the duration of time from time t21 to time t22. When these "1's" are fed to the OR gate 65, the OR gate 65 provides, at the output terminal thereof, a signal that remains at "1" for the duration of time from time t21 to time t24. This signal is fed to the disable control input terminal of the timer 55. The duration from

time t21 to time t24 is thus counted. The digital signal relating to the operational time is fed to the CPU 71 of the information processing device 7.

[0078] The CPU 71 performs a variety of processes, based on the change in the grounded (interconnected) state of the electrodes of 16c1, 16c2, 16c3, 16c4, and 16c5 of the fixed contact assembly 16c and the signal relating to the operational time from the signal output means 5.

[0079] The fourth embodiment provides the same advantages as those of the first embodiment. Furthermore, since the fourth embodiment obtains the digital signal directly from the operational information of the button 14, the resistance measuring unit, the operational amplifier, and the A/D converter are dispensed with.

[0080] <Fifth Embodiment> FIG. 10 is a block diagram of a fifth embodiment of the switching device which is connected to the information processing device. In the fifth embodiment, components identical to those described in connection with the first embodiment are designated with the same reference numerals.

[0081] A switching device 1d shown in FIG. 10 is a modification of the switching device 1c shown in FIG. 5, and is designed to output electrical signals responsive to an operational amount and operational time in the same way as in the first and fourth embodiments. The switching device

1d is electrically connected to the information processing device 7 to feed the electrical signals responsive to an operational amount and operational time to the information processing device 7. The switching device 1d includes a switch 3d which outputs an electrical signal responsive to an operational amount of the switch 3d when the switch 3d is operated, and a signal output means 5d which produces a signal relating to operational time of the switch 3d based on the electrical signal responsive to the operational amount of the switch 3d.

[0082] As in the fourth embodiment, the switch 3d of the fifth embodiment includes a cover 13, a button 14, a movable contact 15d, and a fixed contact assembly 16d. The fifth embodiment is identical to the fourth embodiment in that the button 14 is vertically movably supported on the cover 13 as shown. The fifth embodiment is also identical to the first embodiment in that the button 14 has a movable contact 15d formed of a spherically shaped, electrically conductive rubber G and attached at the bottom end thereof, and in that the button 14 is always upwardly urged by an unshown coil spring, etc. A fixed contact assembly 16d is arranged in a position facing the movable contact 15d. The fixed contact assembly 16c includes a central electrode 16d1, and a plurality of concentric ring electrodes 16c2, 16c3, 16c4, and 16c5 with radial spacings 16d1 between 16c1 and 16c2,

16d2 between 16c2 and 16c3, 16d3 between 16c3 and 16c4, and 16d4 between 16c4 and 16c5. The electrode 16c1 is grounded. The electrodes 16c2, 16c3, 16c4, and 16c5 are directly connected to the interface 32 of the switch 3. The interface 32 receives a clock CLOCK.

[0083] The signal output means 5d is identical to that used in the fourth embodiment, and the discussion thereof is skipped here. The information processing device 7 is fully identical to that used in the first embodiment, and the discussion thereof is also skipped here.

[0084] When the button 14 is pressed down against the urging of an unshown coil spring in the switching device 1d thus constructed, the electrically conductive rubber G of the movable contact 15d is put into contact with the electrode 16d1 of the fixed contact assembly 16d. When the button 14 is further pressed down, the electrically conductive rubber G of the movable contact 15d is deformed into contact with the electrodes 16d1 and 16d2. When the button 14 is even further pressed down, the electrically conductive rubber G of the movable contact 15d is deformed into contact with the electrodes 16d1, 16d2, and 16d3 of the fixed contact assembly 16d. As the contact area of the electrically conductive rubber G of the movable contact 15d is widened, the electrodes 16d1, 16d2, 16d3, 16d4, and 16d5 are gradually grounded. The interconnection relationship

between the electrically conductive rubber G and the electrodes 16d1, 16d2, 16d3, 16d4, and 16d5 is varied depending on the pressing force and speed acting on the button 14. The interconnection relationship of the electrodes 16d1, 16d2, 16d3, 16d4, and 16d5 of the fixed contact assembly 16d is fed to the interface 72 of the information processing device 7, and is then transferred to the CPU 71.

[0085] The signal output means 5d measures a change in the operational time of the switch, and outputs the measured signal to the CPU 71 of the information processing device 7.

[0086] The CPU 71 performs a variety of processes, based on the change in the grounded (interconnected) state of the electrodes of 16d1, 16d2, 16d3, 16d4, and 16d5 of the fixed contact assembly 16d and the signal relating to the operational time from the signal output means 5.

[0087] The fifth embodiment provides the same advantages as those of the first embodiment. Furthermore, since the fourth embodiment obtains the digital signal directly from the operational information of the button 14, the resistance measuring unit, the operational amplifier, and the A/D converter are dispensed with.

[0088] <Sixth Embodiment> FIG. 11 is a block diagram showing a sixth embodiment of the present invention. The

sixth embodiment is arranged by removing the signal output means 5 in the first embodiment and then transferring the signal output means 5 to an information processing device 9. The information processing device 9 includes a CPU 91 and an interface 92.

[0089] The CPU 91 receives a digital signal output from the switch 3, stores a change in the resistance value of a resistance sum R_0 in the form of voltage, and detects, from these pieces of information, a change ΔR in the resistance value, a time segment Δt during which the change ΔR takes place, and an integral of the resistance change. The CPU 91 detects these signals as follows. The CPU 91 samples the resistance sum R_0 at regular intervals, compares the resistance value at this sampling time with the resistance value at the immediately prior sampling time, and determines that the resistance value at the immediately prior sampling time is a minimum value, when the resistance value at this sampling time is larger. From this determination, the CPU 91 determines the time Δt from the start of the change in the resistance value and the change ΔR in the resistance. The CPU 91 determines the integral of the changes in the resistance sum R_0 by summing all resistance values at sampling times. The change ΔR in the resistance sum R_0 , the time segment Δt , and the integral of the changes, thus determined by the CPU 91, are fed to the

information processing device 7. The information processing device 7 may functions as the information processing device 9 as well.

[0090] The embodiment of the switching device described above may be applied in the following fields.

[0091] Each switching device may be used in a joint pad. In this case, the force applied on a button of the pad is compared with several references, and the input state of the button is determined to adjust the strength of an attack by a character in a martial art game, or the speed and strength of throwing motion or kicking motion of a character in a sports game.

[0092] The switching device may be applied in a user recognizing keyboard. The manner in which a user touches the key is learned by a personal computer and is then set as a reference value. The personal computer compares the finger touch of the user with the reference value each time the user touches the keyboard. When a difference is large, the personal computer determines that someone else touches the keyboard, and may lock or reset itself. Data relating to the finger touch may be a speed at which the key is pressed.

[0093] Each of the above switching devices can be applied in a keyboard. When the switching device is applied in a keyboard, a reference is established based on the force

applied on the button, and is stored in a personal computer. The finger touch is compared with the reference value. When the finger touch is strong, an uppercase letter may be selected, and when the finger touch is weak, a lowercase letter may be selected. Alternatively, when the finger touch is strong, a cursor is upward or downward moved on a page by page basis. When the finger touch is weak, the cursor is upward or downward moved on a line by line basis.

[0094] The switching device may be used as a switch for setting time on a watch. When time is set on a watch, a force applied on the button is compared with a reference value. When the force is strong, time setting is performed on a hour by hour basis. When the force is weak, time setting is performed on a minute by minute basis. The switching device may be applied as a switch for setting an operational time of a timer. When the time of the timer is set, a force applied on a button is compared with a reference value. When the force is stronger than the reference value, the operational time is set on a hour by hour basis. When the force is weaker than the reference value, the operational time is set on fifteen minutes by fifteen minutes basis. When the switching device is applied in the timer, the pressing speed of the button may be compared with a reference value. The switching device may be applied as a switch in an alarm clock. The manner in

which the switch is pressed to stop the alarm clock is learned by a computer, and a reference is set by the computer. When a user presses the switch, the computer compares the manner in which the switch has been pressed with the reference, and allows the alarm clock to function again if the difference between is large.

[0095] The switching device may be used as a channel switch of a television receiver. A force applied on the channel switch in the television receiver is learned by a channel CPU, and a resulting reference is stored. By comparing, with the reference, a force that is applied when a channel selection is performed, the manner of channel selection is varied.

[0096] The switching device may be applied as a hot-water discharge control device in a vacuum bottle. The switch is connected to a CPU, and hot water is discharged under the control of the CPU. A hot-water discharge quantity may be controlled to a desired amount according to the downward stroke and downward pressing speed of the switch.

[0097] The switching device may be applied in a device that turns on or off a tap. The opening or closing of the tap is controlled by a CPU. The switching device is connected to the CPU, and a tap water discharge rate is controlled in response to the downward stroke and downward

pressing speed of the switching device.

[0098] The switching device may be applied in a dimmer of illumination equipment. The dimmer includes a CPU, to which the switching device is connected. The operation of the switching device is learned by the CPU to establish a reference. When the switching device is operated, the CPU compares each operation with the reference, thereby adjusting an illumination level of the illumination equipment.

[0099]

[Advantages] As discussed above, in accordance with the present invention, the electrical signal is obtained from the operational amount and the operational time of the switch. The information processing device easily performs complex process without any particular step involved. Particularly, when the switching device of the present invention is applied in the game machine, the operational speed and the operational amount are obtained. The movement of a character presented on a screen is controlled in a complex and detailed motion.

[0100] In accordance with the present invention, the movable contact fabricated of the electrically conductive rubber comes into contact with the fixed contact assembly of two mutually insulated semicircular conductors. The electrically conductive rubber is deformed across the two

conductors, changing the resistance between the two conductors. A change in the resistance is converted into a voltage indicating the operational amount of the switch and the signal output means outputs the electrical signal containing information relating to the operational speed of the switch. These pieces of information are fed to the information processing device, thereby permitting the information processing device to perform complex control.

[0101] In accordance with the present invention, when the movable magnet approaches the fixed coil in the switch, a voltage is generated in the fixed coil through the right-handed screw rule. The signal output means converts the electrical signal into an electrical signal representing the operational amount and operational speed of the switch. These pieces of information are fed to the information processing device, thereby permitting the information processing device to perform complex control.

[0102] In accordance with the present invention, the operation of the button changes the distance between the fixed electrode and the movable electrode, changing the capacitance therebetween. The change in the capacitance is converted into a voltage change, which is then treated as an electrical signal relating to the operational amount of the switch. The signal output means obtains an electrical signal relating to the operational speed from the electrical

signal. These pieces of information are fed to the information processing device, thereby permitting the information processing device to perform complex control.

[0103] When the trapezoidally shaped, electrically conductive, movable rubber contact is put into contact with the fixed contact assembly composed of the plurality of regularly spaced electrodes in a position facing the movable contact in the switch, the electrically conductive rubber is deformed and comes into contact with each electrode. In this way, the contact area of the electrically conductive rubber with each electrode changes. The contact relationship of the movable rubber contact with the plurality of electrodes is directly picked up as a digital signal. The signal output means obtains information relating to the operational time of the switch. These pieces of information are fed to the information processing device, thereby permitting the information processing device to perform complex control. Since the digital signal is directly obtained, the A/D converter is dispensed with.

[0104] When the semi-spherically shaped, electrically conductive, movable rubber contact is in contact with the fixed contact assembly composed of the central electrode placed in the center of the assembly in a position facing the movable contact, and the plurality of regularly spaced rings of electrodes centered on the central

electrode, in the switch, the electrically conductive rubber is deformed, and comes into contact with the electrodes, from the central electrode to radially external electrodes. These pieces of information are fed to the information processing device, thereby permitting the information processing device to perform complex control. Since the digital signal is directly obtained, the A/D converter is dispensed with.

[0105] When the switching device of the present invention is applied in the game machine, the movement of a character is controlled in response to the information such as the magnitude of the pressing force and the operational time of the button. The travel distance, the travel speed, and impact quantity of the character are controlled in a variety of ways.

[Brief Description of the Drawings]

[FIG. 1]

FIG. 1 is a block diagram showing a first embodiment of the switching device of the present invention.

[FIG. 2]

FIG. 2 is a circuit diagram showing a signal output means of the first embodiment.

[FIG. 3]

FIG. 3 shows characteristics of operational signals generated in the first embodiment of the present invention.

[FIG. 4]

FIG. 4 shows the operation of the first embodiment.

[FIG. 5]

FIG. 5 is a block diagram showing a second embodiment of the present invention.

[FIG. 6]

FIG. 6 is a block diagram showing a third embodiment of the present invention.

[FIG. 7]

FIG. 7 is a block diagram showing a fourth embodiment of the present invention.

[FIG. 8]

FIG. 8 is a circuit diagram showing the construction of a signal output means used in the fourth embodiment.

[FIG. 9]

FIG. 9 is a timing diagram showing the operation of the signal output means in the fourth embodiment.

[FIG. 10]

FIG. 10 is a block diagram showing a fifth embodiment of the present invention.

[FIG. 11]

FIG. 11 is a block diagram showing a sixth embodiment of the present invention.

[Reference Numerals]

1 Switching device

3, 3a, 3b, 3c, and 3d Switches
5, 5a, 5b, 5c, and 5d Signal output means
7 Information processing device
9 Information processing device
71 CPU
72 Interface
91 CPU
92 Interface
13 Cover
14 Button
15, 15c, and 15d Movable contacts
15a Movable magnet
15b Movable electrode
16, 16c, and 16d Fixed contacts
16a Fixed coil
16b Fixed electrode
16c1, 16c2, 16c3, 16c4, and 16c5 Electrodes
16d1, 16d2, 16d3, 16d4, and 16d5 Electrodes
19 Spacing
19c1, 19c2, 19c3, and 19c4 Spacings
19d1, 19d2, 19d3, and 19d4 Spacings

DRAWINGS

[FIG. 1]

- 1 SWITCHING DEVICE
- 7 INFORMATION PROCESSING DEVICE
- 5 SIGNAL OUTPUT MEANS
- 72 INTERFACE

[FIG. 2]

- 552 GATE
- 553 COUNTER

[FIG. 7]

- 72 INTERFACE

[FIG. 3]

[FIG. 5]

- 72 INTERFACE

[FIG. 4]

① OUTPUT VOLTAGE OF RESISTANCE MEASURING UNIT 21

② OUTPUT Q OF FLIPFLOP 54

[FIG. 6]

72 INTERFACE

[FIG. 8]

55 TIMER

[FIG. 10]

72 INTERFACE

[FIG. 9]

① OUTPUT OF EXOR GATE 56

② OUTPUT OF EXOR GATE 57

③ OUTPUT OF EXOR GATE 58

④ Q OUTPUT OF FLIPFLOP 59

⑤ Q OUTPUT OF FLIPFLOP 60

⑥ Q OUTPUT OF FLIPFLOP 61

⑦ OUTPUT OF AND GATE 62

⑧ OUTPUT OF AND GATE 63

⑨ OUTPUT OF AND GATE 64

⑩ OUTPUT OF OR GATE 65

[FIG. 11]

1 SWITCHING DEVICE

9 INFORMATION PROCESSING DEVICE
92 INTERFACE

TABLE

[TABLE 1]

- ① Switch operation
- ② Contact area
- ③ Resistance sum R_o
- ④ Switch not operated
- ⑤ Switch operated (with button 14 pressed)

(12)

特開平7-302159

21

22

- 7 情報処理装置
- 9 情報処理装置
- 71 CPU
- 72 インターフェース
- 91 CPU
- 92 インターフェース
- 13 カバー
- 14 ボタン
- 15, 15c, 15d 可動接点
- 15a 可動磁石

- * 15b 可動電極
- 16, 16c, 16d 固定接点
- 16a 固定コイル
- 16b 固定電極
- 16c1, 16c2, 16c3, 16c4, 16c5 電極
- 16d1, 16d2, 16d3, 16d4, 16d5 電極
- 19 間隙
- 19c1, 19c2, 19c3, 19c4 間隔
- 19d1, 19d2, 19d3, 19d4 間隔

*10

【図1】

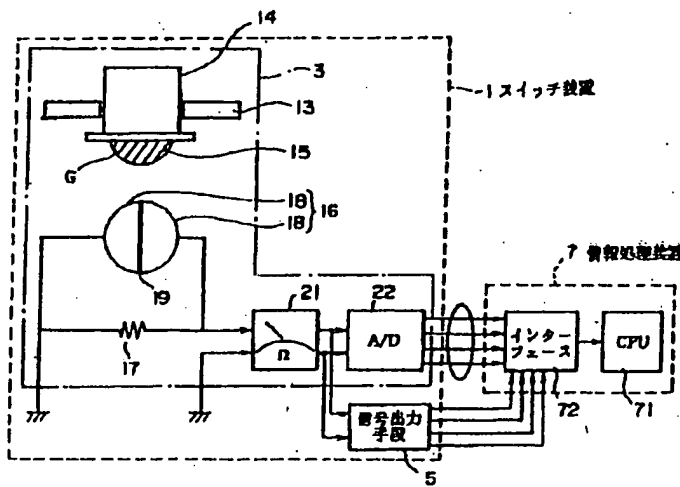

【図7】

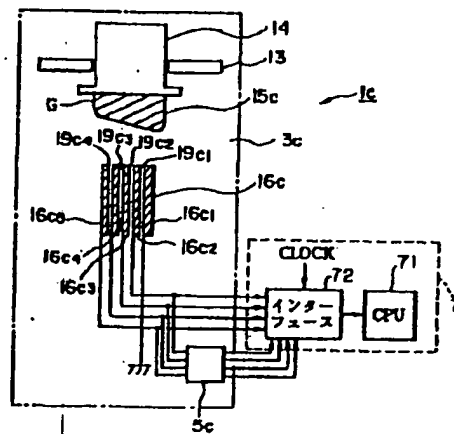

【図2】

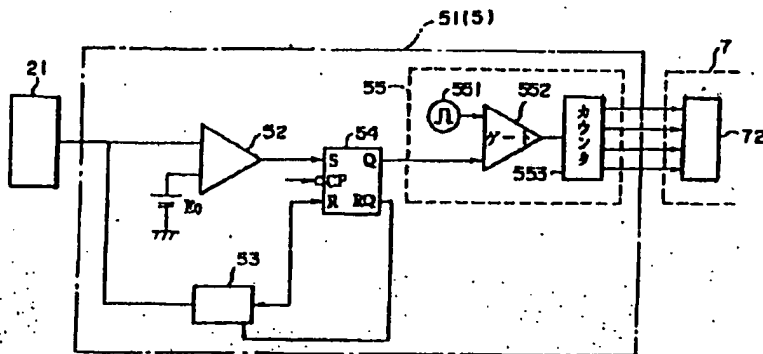

(13)

特開平7-302159

【図3】

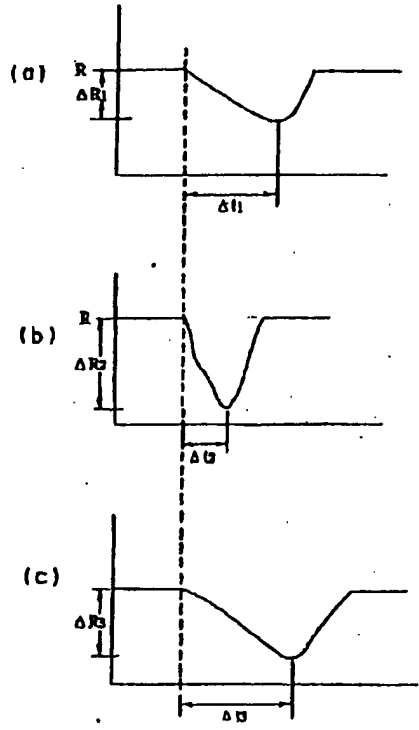

【図5】

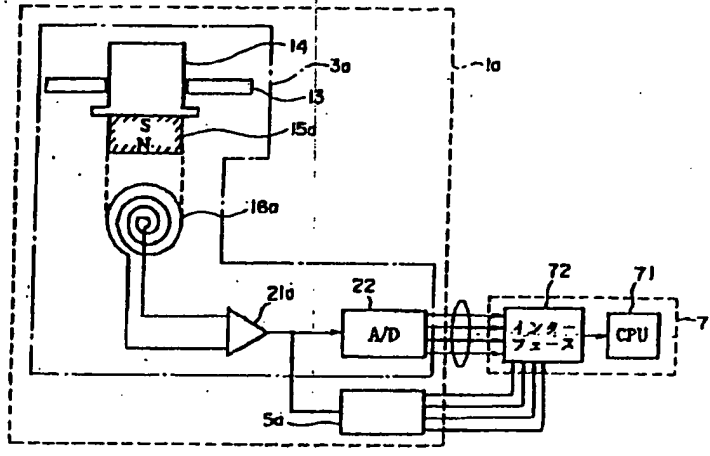

【図4】

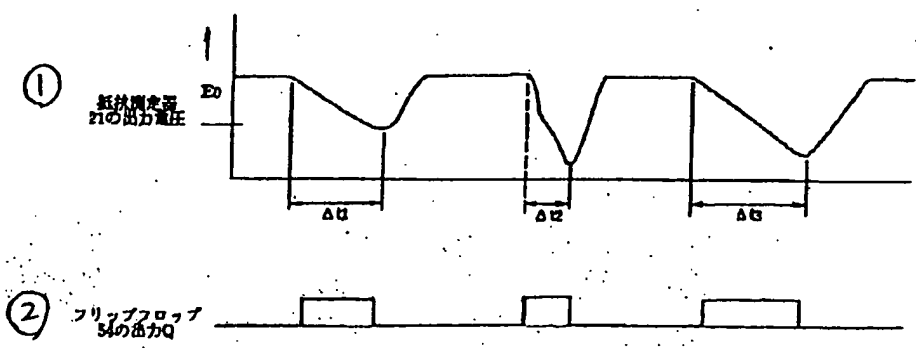

(14)

特開平7-302159

【図6】

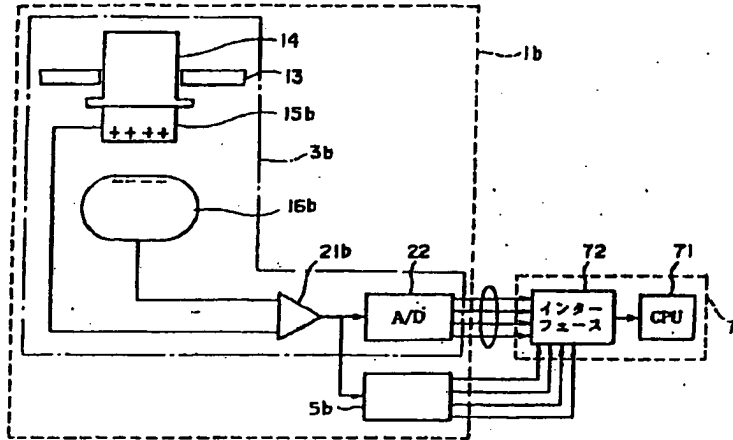

【図8】

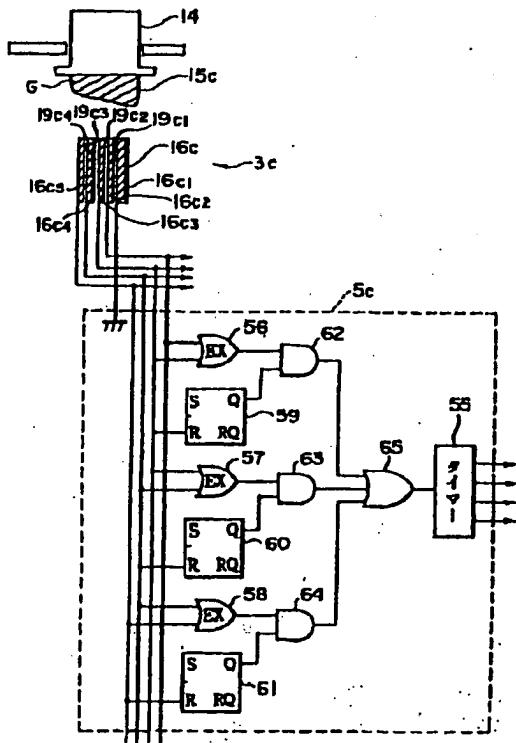

【図10】

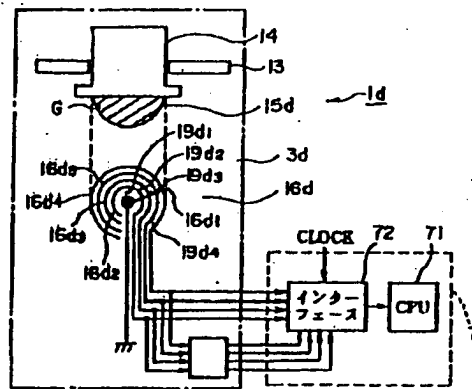

(15)

特開平7-302159

【図9】

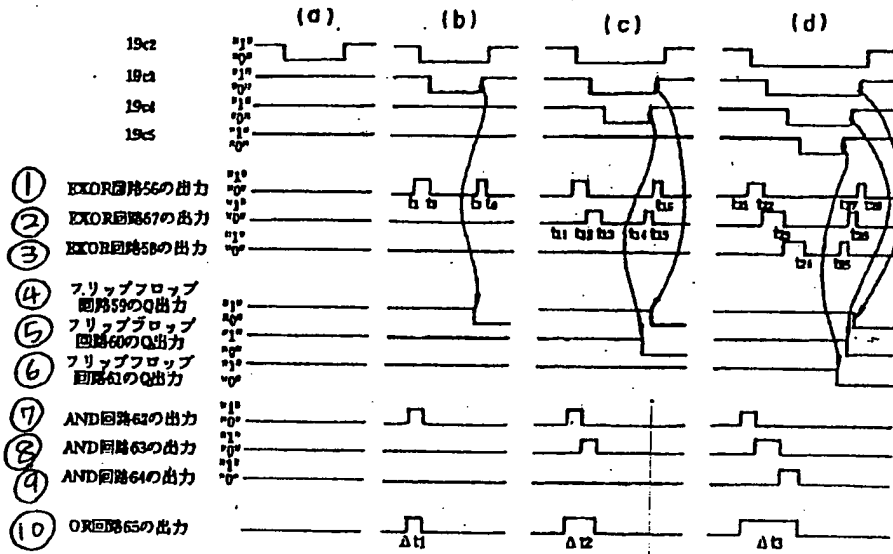

【図11】

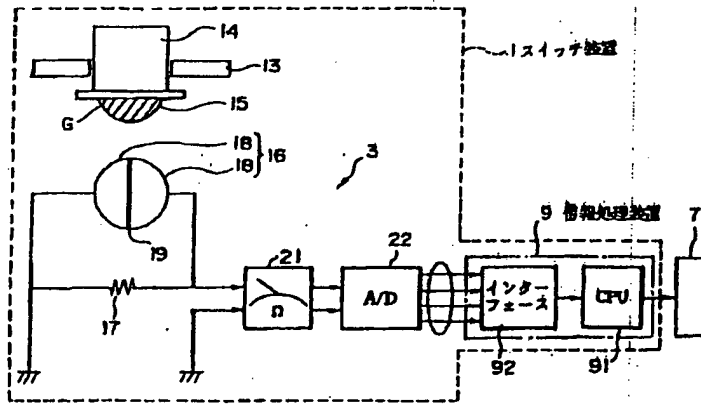

【0036】図2は、信号出力手段5の具体的回路構成例を示すブロック図である。図2において、信号出力手段5は操作時間検出回路51からなり、次のように構成されている。操作時間検出回路51は、コンパレータ52、最大値検出回路53、フリップフロップ回路54、タイマー55とを備えている。前記抵抗測定器21の出力端子は、コンパレータ52及び最大値検出回路53の各入力端子に接続されており、抵抗電圧変換回路1からのアナログ操作量信号が供給されるようになっている。コンパレータ52の出力端子Sは、フリップフロップ回路54のセット端子に接続されている。最大値検出回路53の出力端子は、フリップフロップ回路54のリセット端子Rに接続されている。また、フリップフロップ回路54のクロック端子CPには動作クロックが入力されている。フリップフロップ回路54の非反転出力端子Qはタイマー55の起動停止制御端子に接続されており、出力端子Qが“1”のときのみタイマー55が起動するようにしてある。また、フリップフロップ回路54の反転出力端子RQは最大値検出回路53のリセット端子に接続されている。

【0037】また、タイマー55は、例えば次のように構成すればよい。タイマー55は、基準クロック発生回路551と、ゲート回路552と、カウンタ553とからなり、フリップフロップ回路54の非反転出力端子Qの出力信号をゲート回路552の一方の入力端子に接続し、ゲート回路552の他方入力端子に基準クロック*

*発生回路551の出力端子を接続し、ゲート回路553の出力端子をカウンタ553の入力端子に接続したものでよい。

【0038】このように構成された実施例の動作を図1乃至図4を参照して説明する。なお、図3はスイッチ装置の操作に対応する抵抗値に関する特性が示されており、横軸に時間を、縦軸に抵抗値をとったものである。また、図4は、電圧値の変化に対する操作時間に関する信号の関係を示す図であり、横軸に時間を、縦軸の電圧の変化をとったものである。

【0039】このように構成されたスイッチ装置1によれば、ボタン14を図示しないコイルばねの付勢力に抗して押下すると、可動接点15の導電性ゴムGが固定接点16の半円状導体18、18に接触する。半円状導体18、18同士が可動接点15の導電性ゴムGで接触し、抵抗17の抵抗値より小さくなる。さらに、押下すると、可動接点15の導電性ゴムGが固定接点16の半円状導体18、18に接触しながら変形してゆく。これにより、可動接点15の導電性ゴムGの接触面積が広がり、それに伴って抵抗値をもった導電性ゴムGの半円状導体18、18に対する接触抵抗が徐々に小さくなる。このような導電性ゴムGと半円状導体18、18との接触面積に対する抵抗測定器21が計測する抵抗値の関係の一例について示すと表1のようになる。

【0040】
【表1】

① スイッチの操作	④ 操作なし	⑤ 操作あり (ボタン14を押下した)			
		1cm ²	2cm ²	3cm ²	4cm ²
② 接触面積	0cm ²	1cm ²	2cm ²	3cm ²	4cm ²
③ 合成抵抗R _o	R	R/2	R/3	R/4	R/5

【0041】この表1において、合成抵抗R_oは、抵抗17と導電性ゴムGの接触抵抗による合成抵抗であり、また、抵抗/面積=R/cm²とする。

【0042】このように変化する合成抵抗R_oは抵抗測定器21で計測される。このような合成抵抗R_oの変化は、図3に示すようになる。図3(a)では操作量が小さくかつ操作速度が遅い場合の例であり、合成抵抗R_oの変化ΔR_aが小さく、かつ操作時間Δt_aが長い例を示している。また、図3(b)では操作量が大きくかつ操作速度が早い場合の例であり、合成抵抗R_oの変化ΔR_bが大きく、かつ操作時間Δt_bが短い例を示している。さらに、図3(c)では操作量が大きくかつ操作速度が早い場合の例であり、合成抵抗R_oの変化ΔR_cが大きく、かつ操作時間Δt_cが短い例を示している。

【0043】このような合成抵抗R_oの変化を抵抗測定

器21で計測すると、抵抗測定器21は前記合成抵抗R_oの抵抗値の変化に応じた電圧を発生する。このアナログ信号は、合成抵抗R_oの変化の情報として、抵抗値の変化量ΔRと、その変化の時間Δtと、その変化の積分値との情報が電圧信号に含まれることになる。この抵抗測定器21からの出力電圧は、A/D変換器22でデジタル信号に変換される。

【0044】一方、前記抵抗測定器21から出力されるアナログ信号は、コンパレータ52及び最大値検出回路53に入力される。コンパレータ52では、アナログ信号が所定の基準電圧E_oを超えると“1”を出力する。このコンパレータ52の出力が“1”になると、フリップフロップ回路54はセットされて、フリップフロップ回路54から“1”が出力される。これにより、タイマー55が起動する。すなわち、ゲート回路552が閉